



i WASH LED
coemar

**manuale
di istruzioni
instructions
manual**

1^a edizione provvisoria, Agosto 2004
1st provisional edition. August 2004

iWashLed

numero di serie/serial number

data di acquisto/date of purchase

fornitore/retailer

indirizzo/address

cap/città/suburb

provincia/capital city

stato/state

tel./fax/

Prendete nota, nello spazio apposito, dei dati relativi al modello e al rivenditore del vostro **iWashLed**: in caso di richiesta di informazioni, pezzi di ricambio, servizi di riparazione o altro ci permetteranno di assistervi con la massima rapidità e precisione.

*Please note in the space provided above the relative service information of the model and the retailer from whom you purchased your **iWashLed**: This information will assist us in providing spare parts, repairs or in answering any technical enquiries with the utmost speed and accuracy.*

ATTENZIONE: *la sicurezza dell'apparecchio è garantita solo con l'uso appropriato delle presenti istruzioni, pertanto è necessario conservarle.*

WARNING: *the security of the fixture is granted only if these instructions are strictly followed; therefore it is absolutely necessary to keep this manual.*

Index

1. Packaging	Pag. 5
2. Transportation	" 5
3. Important safety information	" 5
4. Operating voltage and frequency	" 6
5. Installation	" 6
6. Mains connection	" 7
7. Signal connection	" 8
8. Powering up	" 9
9. DMX addressing	" 9
10. Display panel functions	" 10
10.1. Function settings (FUNC)	" 10
10.2. Measure and test (MEAS)	" 11
10.3. Quick guide to menu navigation	" 12
11. DMX channel functions	" 13
12. Turning on the iWashLed with no articulated movement	" 14
13. Automatic repositioning	" 14
14. Altering the operating voltage (reserved for technical personnel)	" 14
15. Maintenance	" 15
16. Electronic motor alignment	" 16
17. Error messages	" 17
18. Spare parts	" 17
19. Troubleshooting	" 17

Congratulations on having purchased a coemar product. You have assured yourself of a fixture of the highest quality, both in componentry and in the technology used. We renew our invitation to you to complete the service information on the previous page, to expedite any request for service information or spares (in case of problems encountered either during, or subsequent to, installation). This information will assist in providing prompt and accurate advice from your coemar service centre.

1. Packaging

Following the instructions and procedures outlined in this manual will ensure the maximum efficiency of this product for years to come.

Open the packaging and ensure that no part of the equipment has suffered damage in transit. In case of damage to the equipment, contact your carrier immediately by telephone or fax, following this with formal notification in writing.

packing list

Ensure the packaging contains:

- 1 **iWashLed**
- 1 **instruction manual**
- 1 **3 A T fuse (for 115V connection or 2 A T for 230V connection)**

2. Transportation

The **iWashLed** deve should be transported in its original packaging or in a coemar approved flight case.

In order to manufacture a suitable flight case, we recommend the following simple procedure to be followed, which will stop the articulated movement of the **iWashLed**.

3. Important safety information

Fire prevention:

1. Never locate the fixture on a flammable surface.
2. Minimum distance from flammable materials: 0,5 m.
3. Minimum distance from the closest illuminable surface: 2 m.
4. Replace any blown or damaged fuses only with those of identical values. Refer to the schematic diagram if there is any doubt.
5. Connect the projector to mains power via a thermal magnetic circuit breaker.

Preventing electric shock:

1. High voltage is present in the internals of the unit. Isolate the projector from mains supply prior to performing any function which involves touching the internals of the unit.
2. For mains connection, adhere strictly to the guidelines outlined in section 7 of this manual.
3. The level of technology inherent in the **iWashLed** requires the use of specialised personnel for all service applications; refer all work to your authorised **coemar** service centre.
4. A good earth connection is essential for proper functioning of the projector.
Never operate the unit without proper earth connection.
5. The fixture should never be located in an exposed position, or in areas of extreme humidity. A steady supply of circulating air is essential.

Safety:

1. The projector should always be installed with bolts, clamps, and other fixings which are suitably rated to support the weight of the unit.
2. Always use a secondary safety chain of a suitable rating to sustain the weight of the unit in case of the failure of the primary fixing point.
3. Never install the fixture in an enclosed area lacking sufficient air flow; the ambient temperature should not exceed 35°C.

Protection against liquids:

1. Neither the projector nor any of its internal components should be allowed to come into contact with any water, oil or any other liquid. Failure to do this will seriously compromise the proper operation of the unit.

Protection against dust:

1. Dust and other impurities can cause damage to the fixture: **iWashLed** has no specific protection against dust and the like, so it is necessary to regularly maintain and clean a fixture which is exposed to such elements.

Risk of fire:

1. Every projector produces heat and so should be located in a well-ventilated position. The minimum distance from flammable materials is 0,5 m, minimum distance from the front of the projector 1m, minimum distance from the closest illuminable surface 2m.

Forced ventilation:

1. You will note that the projector features several air vents and a cooling fan. These should not be obstructed under any circumstances otherwise this may lead to the projector overheating with a consequent risk of serious internal damage.

Ambient temperature:

1. Never install the fixture in a location lacking in adequate ventilation. The ambient temperature should not exceed 35°C.

Protection rating against penetration by solids and liquids:

1. The projector is rated as an ordinary device. Its protection rating against solids and liquids is IP 20

4. Operating voltage and frequency

The projector is able to operate at 100-115-200-208-230-240V; coemar preselects (barring specific requests), an operating voltage of 240 V.

The operating voltage of the projector selected by coemar or its reseller is noted on the base of the unit near to the mains cable.

iWashLed may operate at either 50 or 60 Hz without the need to adjust any settings.

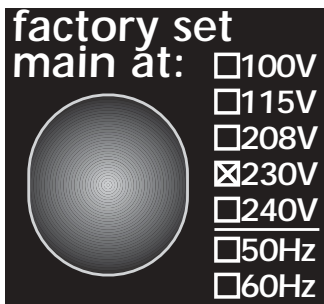

Selecting an alternative operating voltage.

If this preset voltage does not correspond with the conditions in your particular country of operation, follow the instructions in the appropriate section of this manual, section **14. Altering the operating voltage and frequency.**

Incorrect voltage selection will detrimentally affect the operation of the projector and will immediately void the warranty.

5. Installation

mounting

iWashLed may operate in any position.

The structure from which the unit is mounted should be strong enough to support the weight of the unit. For suspension purposes, we recommend the use of suitably rated C-clamps.

The structure from which the unit is hung should be of sufficient rating to hold the weight of the unit and should also be sufficiently rigid so as to not move or shake whilst the **iWashLed** moves during its operation.

The two mounting holes, **A**, on the base of the **iWashLed** allow the attachment of appropriate C-clamps for mounting to truss. Never install the projector in an area where untrained personnel may come into contact with the unit.

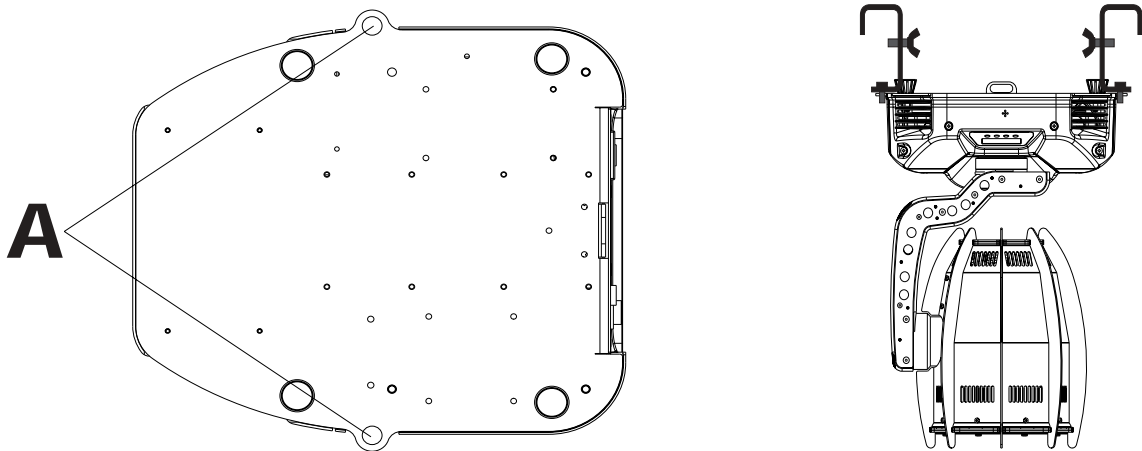

Safety chains

The use of safety chains fixed to the unit and to the primary suspension point is highly recommended to protect against accidental failure, however unlikely, of the primary suspension points.

The safety chains should be attached to the hole,

B, on the rear of the units base, and to the suspension structure.

If using an after-market safety chain not manufactured by coemar, ensure that it is of a sufficient rating to hold the weight of the unit.

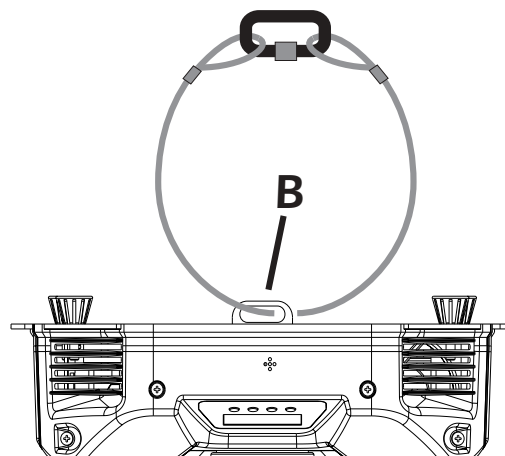

Movement

Do not obstruct the articulated movement of the projector in any way.

6. Mains connection

cabling

The mains cable provided is thermally resistant, conforming to the most recent international standards.

N.B. in case of cable replacement, similar cable with comparable thermal resistant qualities must be used exclusively. (cable 3x1,5 Ø external 8 mm, rated 300/500V, tested to 2KV, operating temperature -40° +180°).

mains connection

iWashLed may operate at 100V-115V-208V-230V-240V at either 50 or 60 Hz (operating voltage should be selected as discussed in section 5 of this manual). Prior to connecting the unit to your mains supply, ensure that the model in your possession correctly matches the mains supply available to you. For connection purposes, ensure that your plug is of a suitable rating: 0,6 amps at 230v and 1,2 amps at 115v.

Locate the mains cable which exits the base of the unit and connect as shown below:

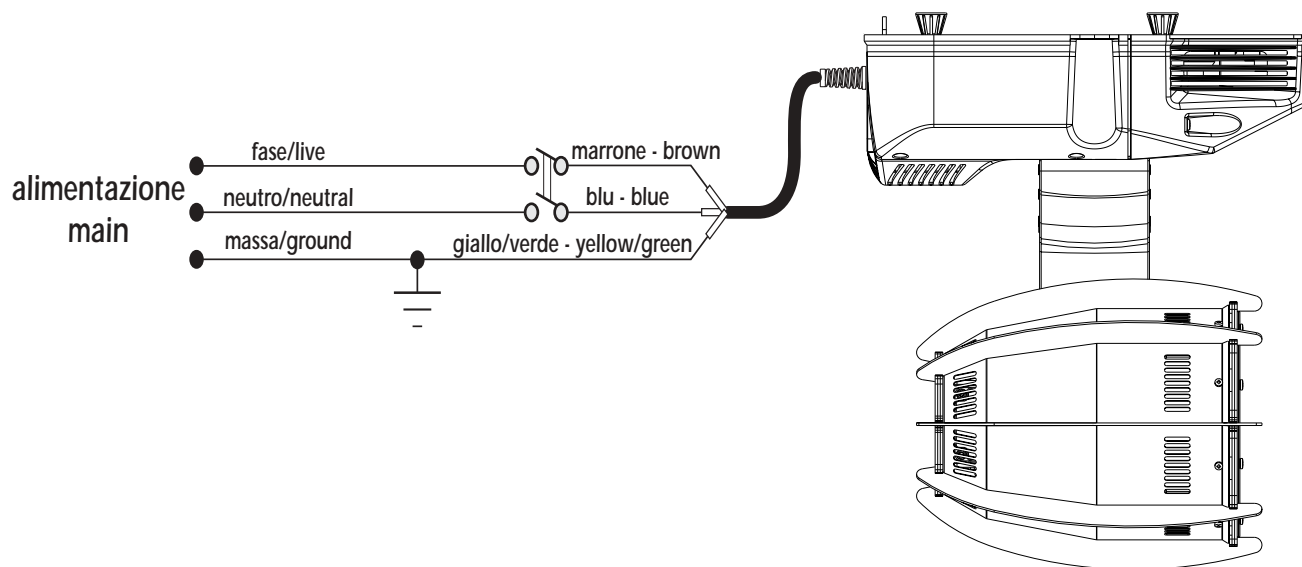

protection

The use of a thermal magnetic circuit breaker is recommended for each projector.

A good earth connection is essential for the correct operation of the fixture. Strict adherence to regulatory norms is strongly recommended.

7. Signal connection

Control signal is digital and is transmitted via two pair screened $\varnothing 0,5$ cable.

Connection is serial, utilising XLR 3 male and female sockets on the base of the **iWashLed**, labeled DMX 512.

If signal output is from a DMX 512 console using cannon XLR5 (5 pin) connectors, do not use pins 4 and 5: leave them unconnected.

Pin connection conforms to international standards:

- | | |
|---------------------------|-----------------------|
| pin 1 = screening 0 volts | pin 4 = not connected |
| pin 2 = data - | pin 5 = not connected |
| pin 3 = data + | |

Signal connection using XLR3 plugs/sockets:

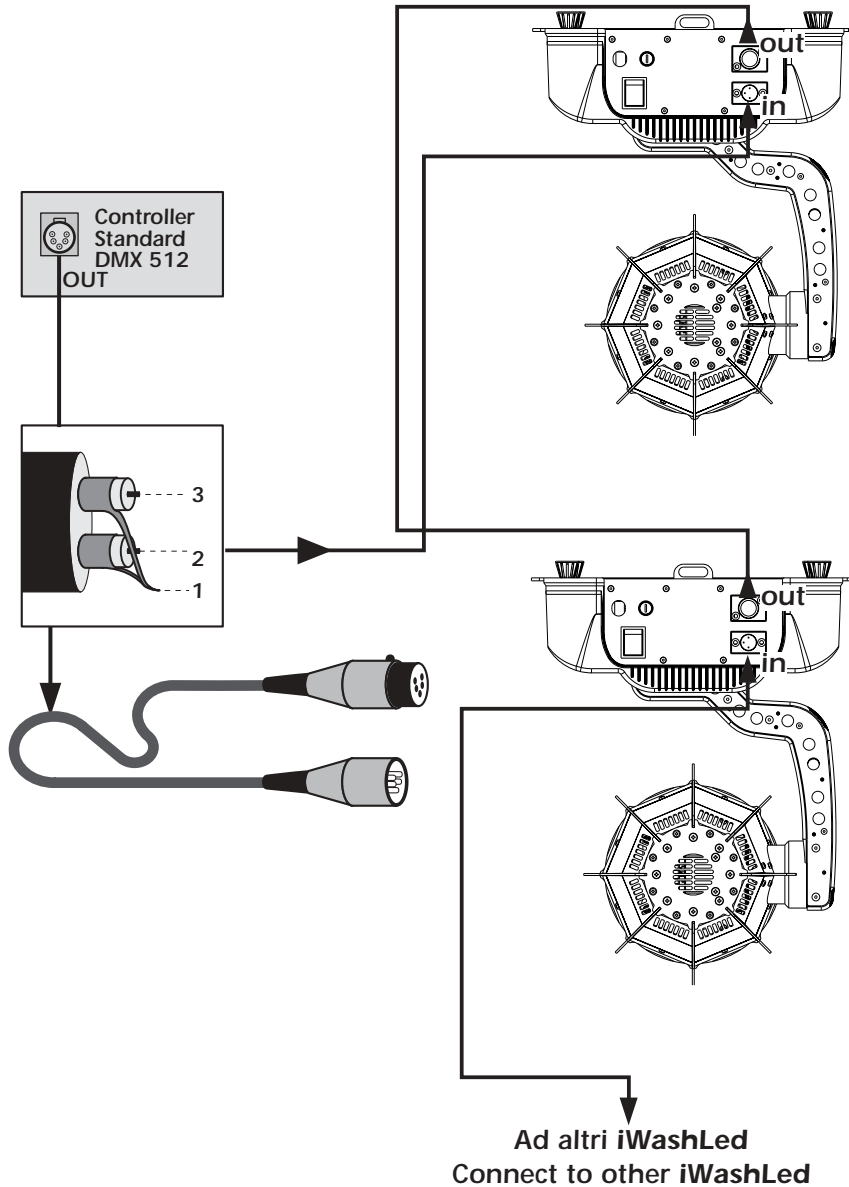

Ensure that all data conductors are isolated from one another and the metal housing of the connector.

N.B. the housing of the cannon XLR3 or 5 non must be isolated.

8. Powering up

After having followed the preceding steps, turn on the projector via the **power** button. Upon powering up, the projector will perform a reset on all its motor, allowing them to be correctly aligned.

Software version

Two software systems are located within the projector, located in the display pcb "**D**" and in the master pcb "**M**". Upon powering up, the display of the projector will, for a few seconds, show the software versions installed in the unit. For example the **iWashLed** may show:

D1.00 (display software "**D**" version **1.00**.)

M1.00 (master software "**M**" version **1.00**.)

DMX reception

After having displayed the software versions, the projector will perform a reset and, following this, the display will stay on in a fixed mode, indicating that the fixture is correctly receiving DMX512 signal.

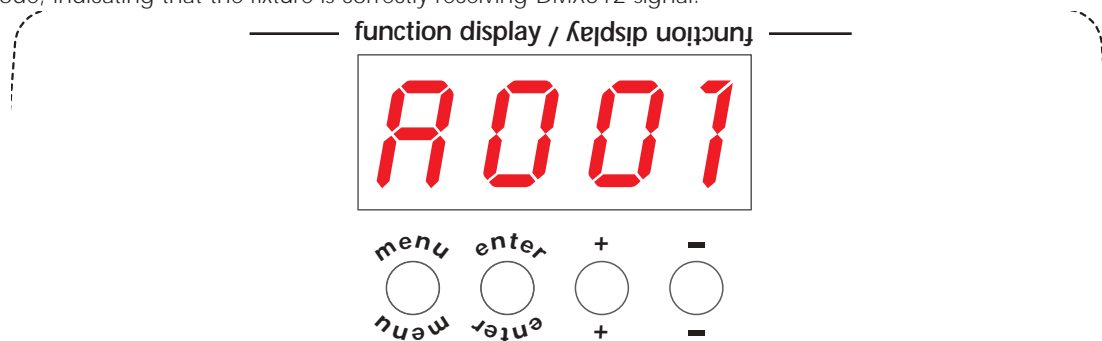

If the display flashed, the projector is not receiving signal. Check the operation of your controller and your cabling.

turning on the projector with no dmx signal present

After having displayed the software versions, the projector will perform a reset and, following this, the display will flash, indicating that the fixture is not receiving **DMX 512** signal.

9. DMX addressing

Each **i-WashLed** utilises, in standard mode, 12 channels of DMX512 control signal for complete control.

DMX 512 addressing

To ensure that each projector accesses the correct signal, it is necessary to correctly address each fixture. Any number between 1 and 499 can be generated via the multifunction panel of the **iWashLed**.

This procedure must be carried out on every **iWashLed**.

When initially powered up, each projector will show **A001** which indicates **DMX address 1**; a projector thus addressed will respond to channels **1** through **12** of your **DMX 512 controller**. **A second projector should be addressed as 13**, a third as **25** and so on until the final **iWashLed**, in relation to the number of channels addressable by your controller.

If the **A001** display flashes, this indicates that the projector is not receiving signal correctly. Check the connection and cabling for any faults.

Altering the DMX address

- 1) Press the **+** or **-** buttons until the required DMX address is located. The display panel will flash to indicate that the currently displayed address is not recorded.

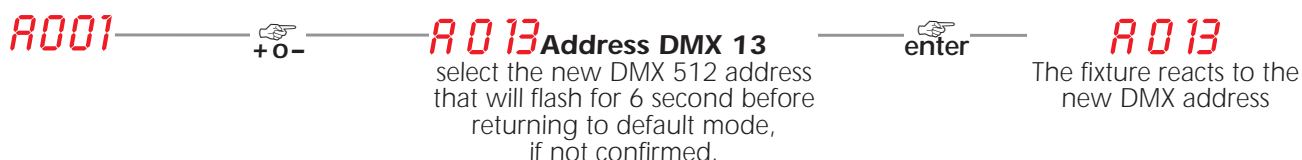

- 2) Press the **enter** button to confirm your selection. The display panel will stop flashing and the fixture will now respond to the newly assigned DMX address.

Important Note:

holding down the **+** or **-** buttons will cause the display to scroll quickly through the channel numbers at an increased speed, allowing a faster selection to be effected.

If the **enter** button is not pressed to confirm the change of DMX address, the projector will automatically return to its original address after some seconds have elapsed

10. Display panel functions

By using the display panel, located on the base of the **iWashLed**, the operator will be able to display and set function information and alter various configuration parameters.

Incorrectly altering the **Coemar** factory settings may vary the functioning of the projector, causing it to not respond to external DMX512 control signal. Please read and familiarise yourself with the following information very carefully prior to altering any selections.

10.1 Function settings (FUNC)

The projector is able to have several function settings altered in order to customise its use to your requirements. The settings made under the "FUNC" operation are always able to be changed.

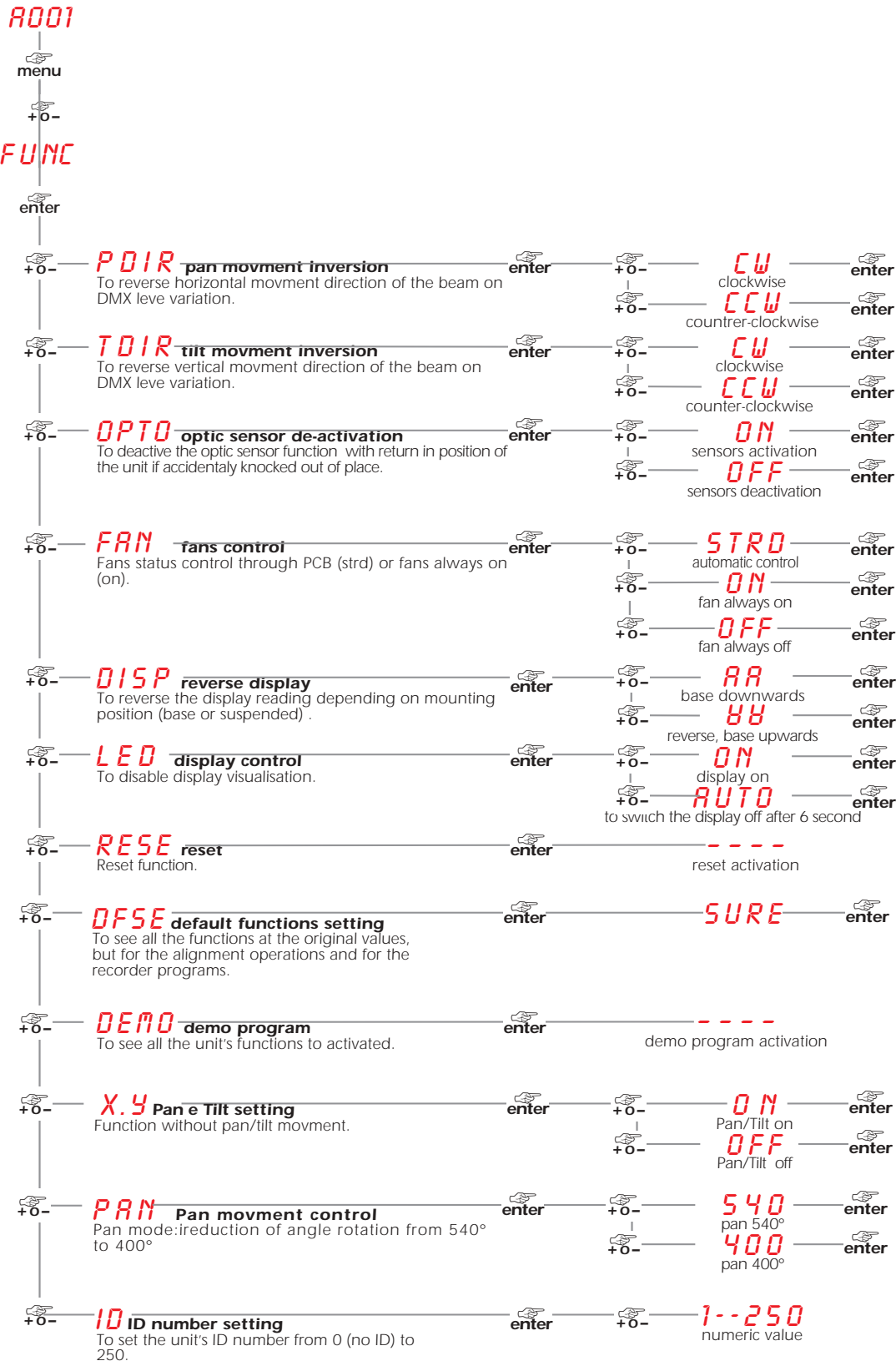

10.2 Measure and Test (MEAS)

The electronic pcbs of the **iWashLed** allow for various digital and auto-diagnostic measurements to be made. You may, in this section, record a home position to which the projector will return when it is turned on in the absence of dmx signal.

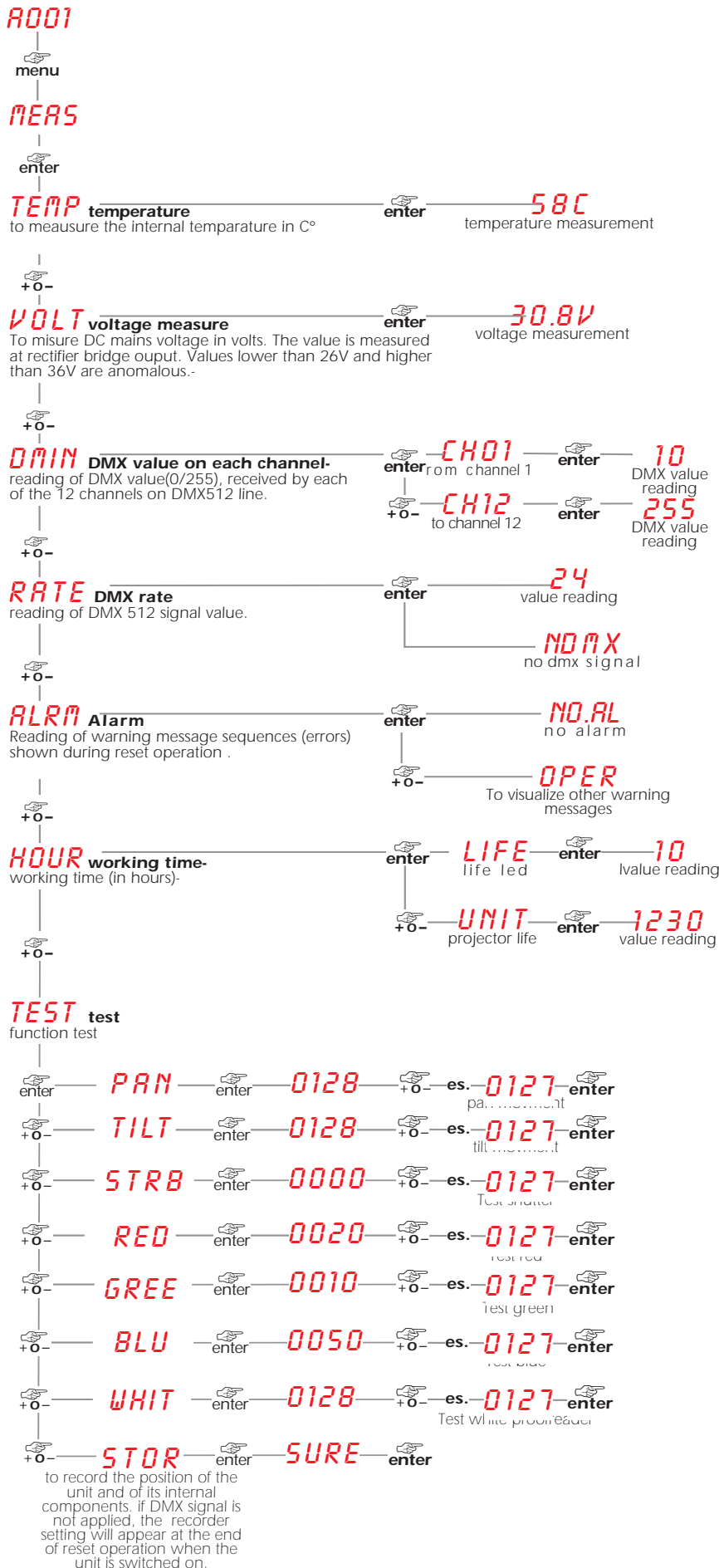

English

10.3 Quick guide to menu navigation

The following guide will allow you to scroll quickly through the various menus located in the display.

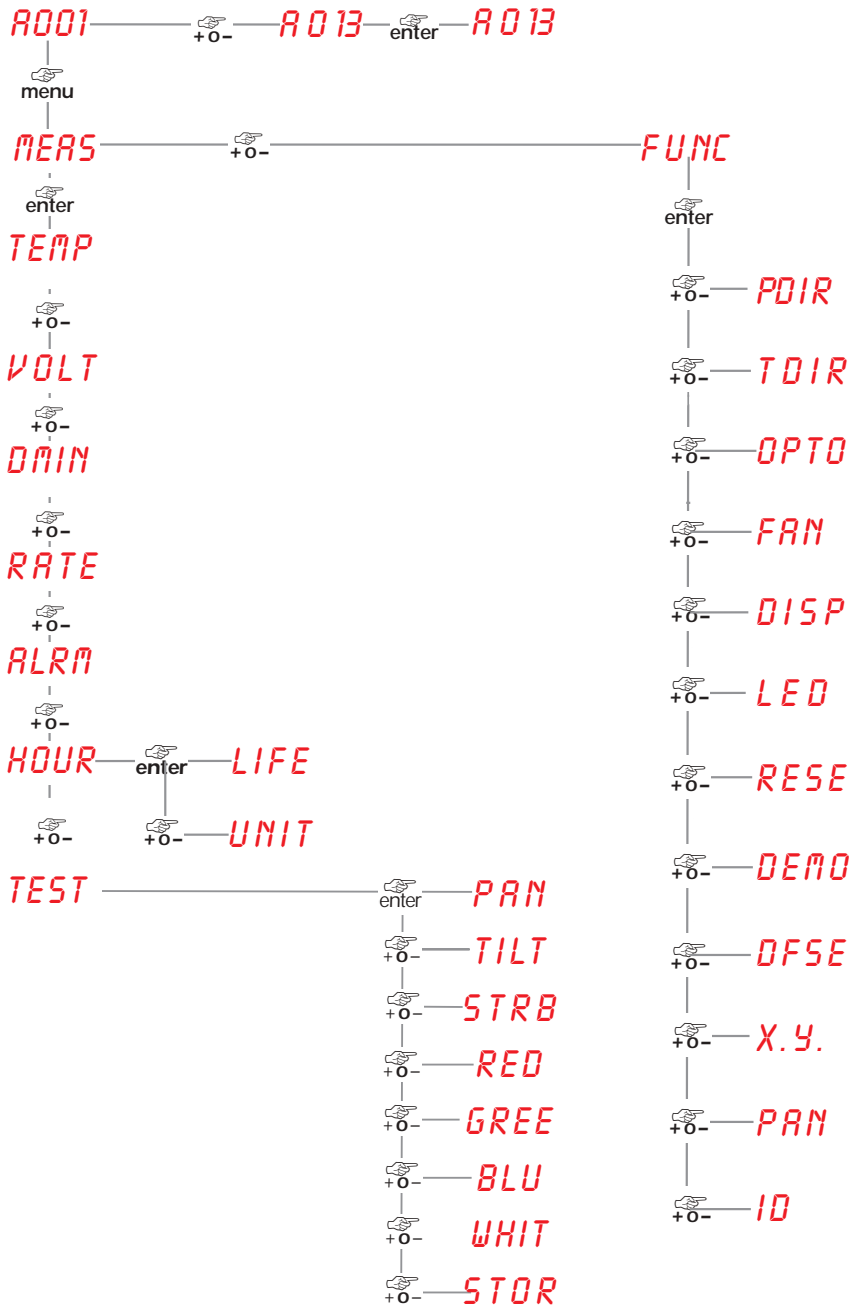

11.4 Rapid scrolling

Via the display of the **iWashLed** it is possible to quickly alter the numerical values associated with the various parameter settings.

There are three methods for doing this:

- 1) Pressing and holding the + or - buttons will cause the display to scroll rapidly in sequence through the numerical values.
- 2) Pressing and holding the + button and then pressing and holding down the - button will cause the display to jump to the highest possible value associated with the respective parameter.
- 3) Pressing and holding the - button and then pressing and holding down the + button will cause the display to jump to the lowest possible value associated with the respective parameter.

11. DMX operation

If all the procedures outlined to this point have been carried out correctly, the 12 channels of your DMX512 controller will have complete control over the various functions of the projector, as described in the table below:

channel	function	type of control	effect	decimal		percentage	
1	X axis, base movement (pan) course	proportional	proportional coarse control of the base motor movement	0	255	0%	100%
2	X axis, base movement (pan) fine	proportional	proportional fine control of the base motor movement	0	255	0%	100%
3	Y axis, yoke movement (tilt) course	proportional	proportional coarse control of the yoke motor movement	0	255	0%	100%
4	Y axis, yoke movement (tilt) fine	proportional	proportional fine control of the yoke motor movement	0	255	0%	100%
5	movement speed	step	standard (fast)	0	10	0%	4%
		step	ultra fast movement (best for programming positions)	11	25	4%	10%
		proportional	vector mode (from fast to slow)	26	127	10%	50%
		proportional	tracking mode (from fast to slow)	128	147	50%	58%
		step	tracking mode (slow)	148	255	58%	100%
6	dimmer	proportional	gradual adjustment of dimmer from 0 to 100%	0	255	0%	100%
7	strobe	step	no effect	0	9	0%	4%
		proportional	strobe effect from slow to fast	10	57	4%	22%
		step	stop strobe	58	59	23%	23%
		proportional	sequenced pulse effect: slow close, fast open (frequency adjustment from slow to fast)	60	108	24%	42%
		step	stop strobe	109	110	43%	43%
		proportional	sequenced pulse effect: fast close, slow open (frequency adjustment from slow to fast)	111	159	44%	62%
		step	stop strobe	160	161	63%	63%
		proportional	random strobe effect, synchronised, from slow to fast	162	207	64%	81%
step	stop strobe	208	209	82%	82%		
proportional	random strobe effect, non-synchronised, from slow to fast	210	255	82%	100%		
8	red	proportional	proportional control of the percentage of red colour from 0 to 100%	0	255	0%	100%
9	green	proportional	proportional control of the percentage of green colour from 0 to 100%	0	255	0%	100%
10	blue	proportional	proportional control of the percentage of blue colour from 0 to 100%	0	255	0%	100%
11	white colour balance	proportional	proportional control of the intensity of the white colour balance	0	255	0%	100%
12	motor reset	step	no effect	0	100	0%	39%
			reset of the pan/tilt motors (once only)	101	170	40%	67%
			black-out of the beam during PAN/TILT movements	171	200	67%	78%
			fan at maximum speed	201	240	79%	94%
			allows independent control of the white colour balance	241	255	95%	100%
Fixture: iWash Led			Table name: DMX 512				
Table number:240		Edition:0	Date: 03/06/2004				

12. Turning on the iWashLed without articulated movement

This procedure may be useful in situations where the **iWasLed** may need to be switched on in an enclosed space, such as in its flight case.

1) Turn on the projector whilst holding down the **menu**, **enter** and **-** buttons simultaneously. The projector will perform a reset of its electronic systems without movement in the pan and tilt motors.

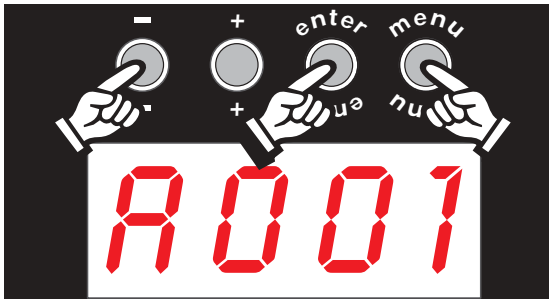

2) You may alter the DMX address or any other parameter at this point without any articulated movement.

3) To return to normal operation, turn the unit off and on via the power button, or effect a reset via the menu system.

13. Automatic repositioning

An encoder system based on 4 position indicators allows the **iWashLed** to return to its correct position if it is accidentally moved during operation. This is particularly useful if the projector is to be mounted on the floor in a position where the performer or artist may accidentally bump the unit.



14. Altering the operating voltage (reserved for technical staff)

If the operating voltage set by coemar does not correspond to that in use in your country of operation, or if the projector is destined for use in another country, a new operating voltage selection may be made as described below.

Incorrect voltage selection will detrimentally affect the operation of the projector and immediately void the warranty.

Attention!!!

Remove mains power prior to opening up the projector!

14.1 selecting transformer operating voltage

1) Using a Philips head screwdriver, remove the 4 screws which affix the cover on the base, as shown in the diagram below. Completely remove the cover, thus providing full access to the internal components.



2) Locate the transformer on the right of the base.

3) Select the required voltage from amongst 100V-115V-208V-230V-240V by removing the cable n.7 and moving it to the appropriate position. Refer to the sticker on the transformer to ensure you are selecting the correct voltage.

Cable n.6 should not be moved under any circumstances.



4) If your operating voltage is set at 100V or 115V, replace the 0,6 Amp T fuse, which is suitable for 208V-230V-240V operation, with one rated at 1,2 Amps T in the fuse holder on the base of the unit. A replacement fuse is provided with this manual.



T 2A @230V
T 3A @115V



5) Replace the base cover and refasten the 4 screws.

15. Maintenance

Whilst every possible precaution has been taken to ensure the trouble-free operation of your **iWashLed**, the following periodic maintenance is highly recommended. Prior to undertaking any maintenance procedure, make sure the fixture is disconnected from mains power.

Attention!!!

Remove mains power prior to opening up the projector!

Periodic cleaning:

The fans and air passages must be cleaned approximately every 6 weeks; the period for this cleaning will depend, of course, upon the conditions in which the projector is operating. Suitable instruments for performing this type of maintenance are a brush and a common vacuum cleaner or an air compressor.

Fuse replacement:

Locate the fuse which protects the fixture's circuitry. Use a multimeter to check the condition of the fuse, replacing it with one of similar value and dimensions if necessary.

periodic cleaning:

mechanicals

Periodically check all mechanical devices for wear and tear, gears, guides, belts, etc, replacing them if necessary. Periodically check for mechanical damage and replace components as required. Check the tensioning of all belts and adjust if necessary.

electrical components

Check all electrical components for correct earthing and proper attachment of all connectors, refastening if necessary.

16. Electronic motor alignment

Attention!!!

The procedures outlined in this section of the manual should only be undertaken by qualified technical personnel.

The display panel of the **iWashLed** allows for the **electronic alignment of the projector's motors**. This procedure is performed by **coemar** at the factory. It may be useful to perform this procedure in the case of internal components being replaced. Altering the factory settings may radically alter the functioning of the projector. Carefully read all of the following prior to attempting any following prior to attempting any changes.

electronic calibration

Attention!

Calibration is only possible if the projector is receiving **DMX 512** signal.

- 1) Press the menu button.
- 2) Press the **+** or **-** button until **RESE** (for reset) is displayed.
- 3) Simultaneously press the **enter** and **menu** buttons, holding them down for at least **30"**. The movement motors will perform a reset and the display will show **---** for a few seconds, confirming you are in calibration mode:

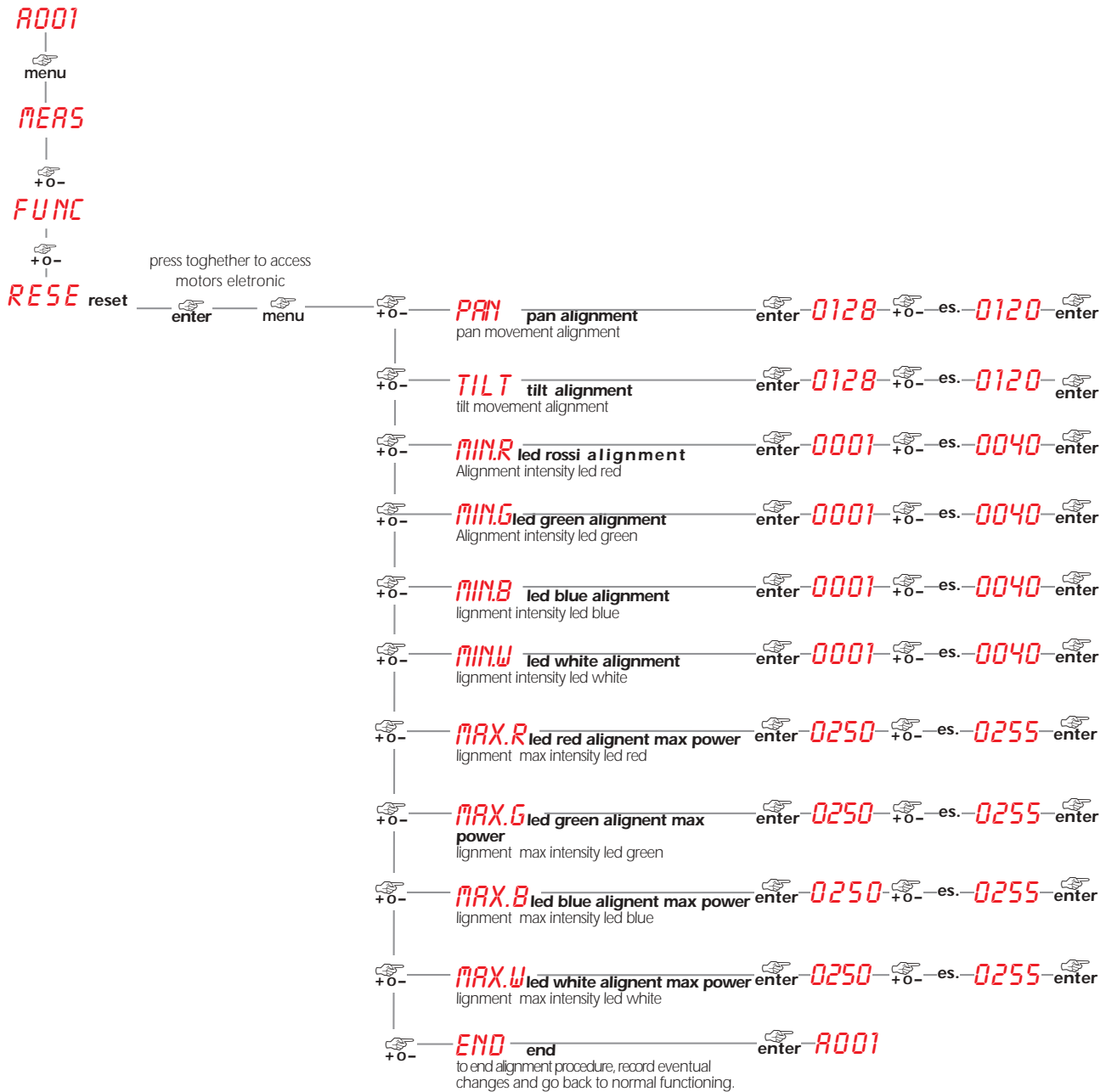

Note: Simultaneously pressing the **+** and **-** buttons will cause the display value to return to 128 (default).

17. Error messages

MBER:	COMMUNICATION Error The display panel is not communicating correctly with the main pcb; check the flat ribbon cable which connects the two.
OPER:	PAN ENCODER Error This message indicates that there is a problem with the PAN Encoders: Check the sensors and all associated cabling on the wheel which is used to determine the PAN movement in the base
OTER:	TILT ENCODER Error This message indicates that there is a problem with the TILT Encoders: Check the sensors and all associated cabling on the wheel which is used to determine the TILT movement in the yoke
EPER:	EEPROM Error The EEPROM is either defective or is absent; refer to your coemar service centre for a replacement component.
OTER:	DATA Error The initial parameter settings are either incorrect or corrupt, the projector has reloaded its factory defaults: Turn the projector off and on again. Should the error reoccur, refer the unit to your authorised service centre for a replacement EEPROM
ADER:	DMX ADDRESS Error The projector is not receiving all DMX channels needed for proper functioning. Check the DMX address on the display and the control channels being output by the controller. Note that some controllers can only output 512 channels.
ER20 ÷ ER99:	SYSTEM Error Turn the unit off and on again. Should the error reoccur, refer it to your authorised coemar service centre.

18. Spare parts

All the components of the **iWashLed** are available as spare parts from your authorised **coemar** service centre. Accurate description of the fixture, model number and type will assist us in providing for your requirements in an efficient and effective manner.

19. Troubleshooting

Problem	Possible cause	Possible solution
A projector is completely immobile.	No power. The circuit breaker has tripped off. The protection fuse may be blown.	Check that the mains power cable is connected to a powered outlet (see sections.6 - 7). Turn the power switch to the ON position. Turn off the projector and replace the fuse.
The projector resets correctly but does not respond, or responds incorrectly, to incoming DMX signal.	Incorrect connection. Incorrect DMX addressing The cannon plugs wiring connection may be incorrect or faulty.	Check the connecting cables, reconnect the signal cable properly, repair or substitute any faulty or damaged cable. Check the fixtures DMX address. Repair or replace the signal cable.

Indice

1. Imballo	Pag. 5
2. Trasporto	" 5
3. Importanti informazioni di sicurezza	" 5
4. Tensione e frequenza di funzionamento	" 6
5. Fissaggio meccanico	" 6
6. Connessione alla rete elettrica	" 7
7. Connessione di segnale	" 8
8. Alimentazione	" 9
9. Indirizzi DMX	" 9
10. Funzioni del pannello display	" 10
10.1. Settaggi funzionali (FUNC)	" 10
10.2. Misure e test (MEAS)	" 11
10.3. Guida rapida al menu di navigazione	" 12
11. Funzionamento con segnale DMX	" 13
12. Accensione di iWashLed senza movimento	" 14
13. Dispositivo di ritorno in posizione automatica	" 14
14. Variazione della tensione di funzionamento (Riservato ai tecnici)	" 14
15. Manutenzione	" 15
16. Allineamento elettronico dei motori e taratura dei Led	" 16
17. Messaggi di errore	" 17
18. Parti di ricambio	" 17
19. Domande e risposte	" 17